

Dosing for Infants and Children

From Your Healthcare Professional

Concentrated
Motrin
Infants' Drops

Children's
Motrin

DOSE: Every 6-8 hours as needed. DO NOT GIVE MORE THAN 4 DOSES IN 24 HOURS.

If possible, use weight to dose; otherwise use age.

mL = milliliter
tsp = teaspoon



Infants' MOTRIN® Concentrated Drops

Active Ingredient:
Ibuprofen 50 mg (NSAID)*
(in each 1.25 mL)

*Nonsteroidal anti-inflammatory drug
Use only as directed.

Available in:
Dye-Free Berry







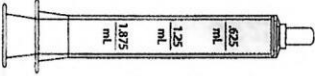
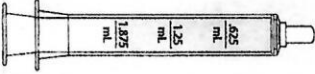

Children's MOTRIN® Oral Suspension

Active Ingredient:
Ibuprofen 100 mg (NSAID)*
(in each 5 mL or 1 tsp)

*Nonsteroidal anti-inflammatory drug
Use only as directed.

Available in:
Original Berry
Dye-Free Berry

WEIGHT	AGE	Infants' MOTRIN® Concentrated Drops	Children's MOTRIN® Oral Suspension
—	<6 mos	—	—
12-17 lbs	6-11 mos	1.25 mL 	—
18-23 lbs	12-23 mos	1.875 mL 	—
24-35 lbs	2-3 yrs	—	5 mL (1 tsp) 
36-47 lbs	4-5 yrs	—	7.5 mL (1½ tsp) 
48-59 lbs	6-8 yrs	—	10 mL (2 tsp) 
60-71 lbs	9-10 yrs	—	12.5 mL (2½ tsp) 
72-95 lbs	11 yrs	—	15 mL (3 tsp) 

IMPORTANT INSTRUCTIONS for Proper Use

Today's Date: _____

This dosing recommendation from your doctor will expire in 14 DAYS.

- Read and follow the label on all MOTRIN® products
- Repeat dose every 6-8 hours as needed
- Do NOT give more than 4 doses in 24 hours
- Use only the dosing device (syringe or dosing cup) that came with the product